

Cambridge  
International  
AS & A Level

**Cambridge International Examinations**  
Cambridge International Advanced Subsidiary and Advanced Level

**PHYSICS**

**9702/12**

Paper 1 Multiple Choice

**October/November 2016**

**1 hour 15 minutes**

Additional Materials: Multiple Choice Answer Sheet  
Soft clean eraser  
Soft pencil (type B or HB is recommended)

\* 1 0 4 7 5 0 9 7 9 7 \*

**READ THESE INSTRUCTIONS FIRST**

Write in soft pencil.

Do not use staples, paper clips, glue or correction fluid.

Write your name, Centre number and candidate number on the Answer Sheet in the spaces provided unless this has been done for you.

**DO NOT WRITE IN ANY BARCODES.**

There are **forty** questions on this paper. Answer **all** questions. For each question there are four possible answers **A, B, C** and **D**.

Choose the **one** you consider correct and record your choice in **soft pencil** on the separate Answer Sheet.

**Read the instructions on the Answer Sheet very carefully.**

Each correct answer will score one mark. A mark will not be deducted for a wrong answer.

Any working should be done in this booklet.

Electronic calculators may be used.

This document consists of **19** printed pages and **1** blank page.

**Data**

speed of light in free space	$c = 3.00 \times 10^8 \text{ m s}^{-1}$
permeability of free space	$\mu_0 = 4\pi \times 10^{-7} \text{ H m}^{-1}$
permittivity of free space	$\epsilon_0 = 8.85 \times 10^{-12} \text{ F m}^{-1}$ $\left(\frac{1}{4\pi\epsilon_0} = 8.99 \times 10^9 \text{ m F}^{-1}\right)$
elementary charge	$e = 1.60 \times 10^{-19} \text{ C}$
the Planck constant	$h = 6.63 \times 10^{-34} \text{ J s}$
unified atomic mass unit	$1 \text{ u} = 1.66 \times 10^{-27} \text{ kg}$
rest mass of electron	$m_e = 9.11 \times 10^{-31} \text{ kg}$
rest mass of proton	$m_p = 1.67 \times 10^{-27} \text{ kg}$
molar gas constant	$R = 8.31 \text{ J K}^{-1} \text{ mol}^{-1}$
the Avogadro constant	$N_A = 6.02 \times 10^{23} \text{ mol}^{-1}$
the Boltzmann constant	$k = 1.38 \times 10^{-23} \text{ J K}^{-1}$
gravitational constant	$G = 6.67 \times 10^{-11} \text{ N m}^2 \text{ kg}^{-2}$
acceleration of free fall	$g = 9.81 \text{ m s}^{-2}$

## Formulae

uniformly accelerated motion	$s = ut + \frac{1}{2}at^2$ $v^2 = u^2 + 2as$
work done on/by a gas	$W = p\Delta V$
gravitational potential	$\phi = -\frac{Gm}{r}$
hydrostatic pressure	$p = \rho gh$
pressure of an ideal gas	$p = \frac{1}{3} \frac{Nm}{V} \langle c^2 \rangle$
simple harmonic motion	$a = -\omega^2 x$
velocity of particle in s.h.m.	$v = v_0 \cos \omega t$ $v = \pm \omega \sqrt{(x_0^2 - x^2)}$
Doppler effect	$f_o = \frac{f_s v}{v \pm v_s}$
electric potential	$V = \frac{Q}{4\pi\epsilon_0 r}$
capacitors in series	$1/C = 1/C_1 + 1/C_2 + \dots$
capacitors in parallel	$C = C_1 + C_2 + \dots$
energy of charged capacitor	$W = \frac{1}{2}QV$
electric current	$I = Anvq$
resistors in series	$R = R_1 + R_2 + \dots$
resistors in parallel	$1/R = 1/R_1 + 1/R_2 + \dots$
Hall voltage	$V_H = \frac{BI}{ntq}$
alternating current/voltage	$x = x_0 \sin \omega t$
radioactive decay	$x = x_0 \exp(-\lambda t)$
decay constant	$\lambda = \frac{0.693}{t_{\frac{1}{2}}}$

- 1 Concrete has a density of  $2400 \text{ kg m}^{-3}$ .

Which mass of concrete fills a rectangular space of dimensions  $8.0 \text{ cm} \times 90 \text{ cm} \times 110 \text{ cm}$ ?

- A 79 kg                      B 190 kg                      C 790 kg                      D 1900 kg

- 2 The speed  $v$  of sound in a gas is given by the equation

$$v = \sqrt{\frac{\gamma P}{\rho}}$$

where  $P$  is the pressure of the gas,  $\rho$  is its density and  $\gamma$  is a constant.

What are the SI base units of  $\gamma$ ?

- A  $\text{m}^{-1} \text{s}$                       B  $\text{m}^3 \text{s}^{-3}$                       C  $\text{m}^{-4} \text{s}^{-4}$                       D no units

- 3 The motion of an object moving from rest with a constant acceleration  $a$  may be represented by the equation shown.

$$v^2 = 2as$$

Which row describes the quantities represented by the symbols  $v$  and  $s$ ?

	$v$	$s$
<b>A</b>	scalar	scalar
<b>B</b>	scalar	vector
<b>C</b>	vector	scalar
<b>D</b>	vector	vector

- 4 A cathode-ray oscilloscope (c.r.o.) displays a waveform as shown.

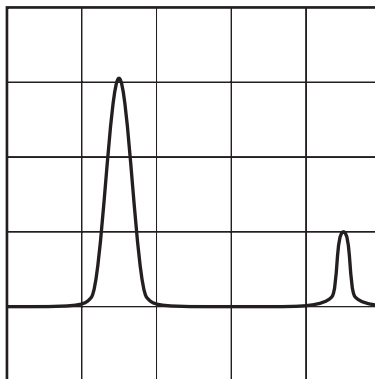

The time interval between two adjacent peaks of the waveform is 0.006 s.

What is the time-base setting of the c.r.o.?

- A  $2 \mu\text{s}/\text{division}$
  - B  $20 \mu\text{s}/\text{division}$
  - C  $2 \text{ms}/\text{division}$
  - D  $3 \text{ms}/\text{division}$
- 5 A value for the acceleration of free fall on Earth is given as  $(10 \pm 2) \text{m s}^{-2}$ .

Which statement is correct?

- A The value is accurate but not precise.
  - B The value is both precise and accurate.
  - C The value is neither precise nor accurate.
  - D The value is precise but not accurate.
- 6 An experiment to determine atmospheric pressure  $P$  uses the equation  $P = \rho gh$  where

$$\rho = (13600 \pm 100) \text{kg m}^{-3},$$

$$g = (9.81 \pm 0.02) \text{m s}^{-2},$$

$$h = (0.762 \pm 0.005) \text{m}.$$

What is the value of  $P$ , with its uncertainty, when stated to an appropriate number of significant figures?

- A  $(1.0166 \pm 0.0162) \times 10^5 \text{Pa}$
- B  $(1.017 \pm 0.016) \times 10^5 \text{Pa}$
- C  $(1.017 \pm 1.6\%) \times 10^5 \text{Pa}$
- D  $(1.02 \pm 0.02) \times 10^5 \text{Pa}$

- 7 A lorry travels at a constant speed and then decelerates until it stops.

Which graph shows the variation with time of the distance travelled by the lorry?

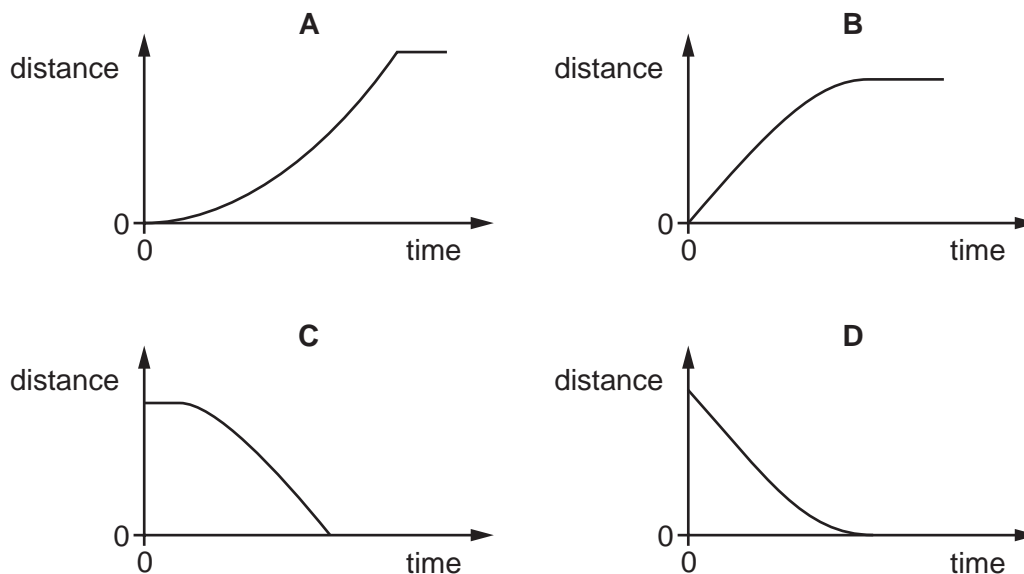

- 8 The graph shows the vertical velocity of a parachutist during the first 20 s of her jump.

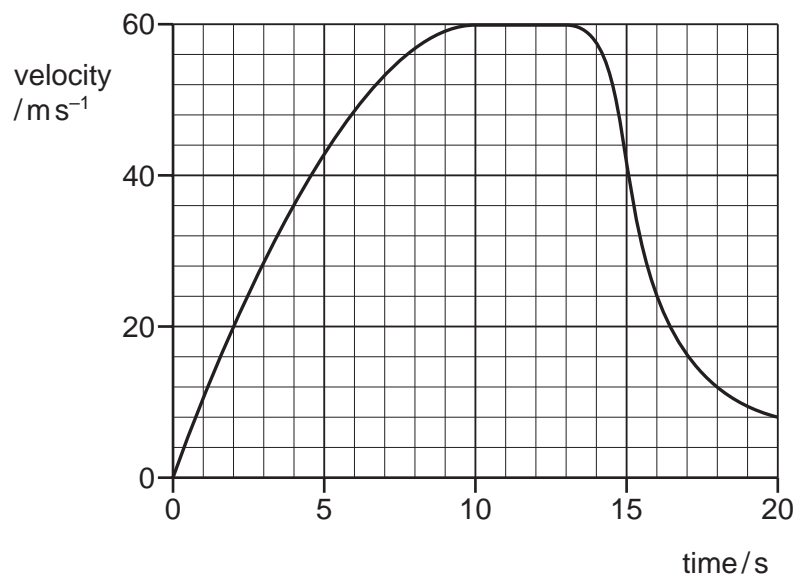

Approximately how far does she fall **before** opening the parachute?

- A 390 m      B 570 m      C 710 m      D 770 m

- 9 A girl is jumping on a trampoline.

Which graph shows the variation of the girl's velocity  $v$  with time  $t$ ?

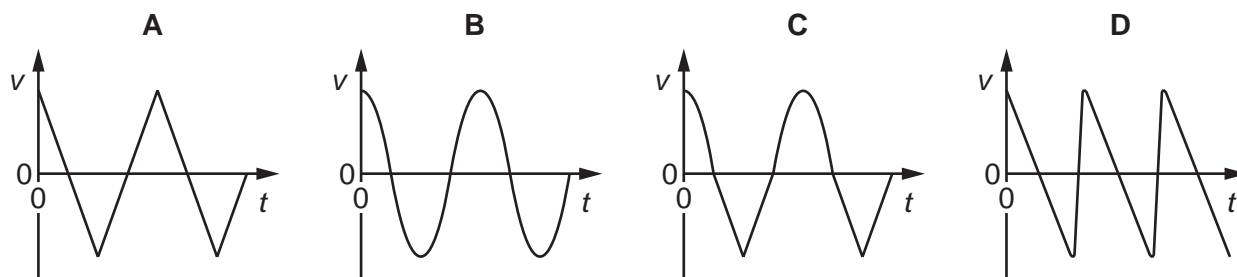

- 10 In order that a train can stop safely, it will always pass a signal showing a yellow light before it reaches a signal showing a red light. Drivers apply the brake at the yellow light and this results in a uniform deceleration to stop exactly at the red light.

The distance between the red and yellow lights is  $x$ .

If the speed of the train is increased by 20%, without changing the deceleration of the train, what must be the minimum distance between the lights?

- A  $1.20x$       B  $1.25x$       C  $1.44x$       D  $1.56x$
- 11 Two frictionless trolleys are moving towards each other along the same horizontal straight line. Their masses and velocities are shown.

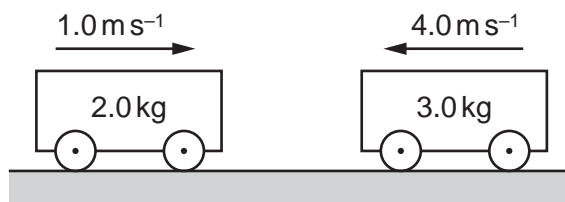

The trolleys collide and stick together.

What is the velocity of the trolleys after the collision?

- A  $2.0 \text{ m s}^{-1}$  to the left  
 B  $2.0 \text{ m s}^{-1}$  to the right  
 C  $2.8 \text{ m s}^{-1}$  to the left  
 D  $2.8 \text{ m s}^{-1}$  to the right
- 12 A bullet of mass  $8.0 \text{ g}$  travels at a speed of  $300 \text{ m s}^{-1}$ . The bullet hits a target and stops after a time of  $100 \mu\text{s}$ .

What is the average force exerted by the target on the bullet?

- A 24 N      B 240 N      C 2400 N      D 24 000 N

13 A light ball is falling vertically through air.

The variation with time  $t$  of the resistive force  $F_R$  acting on the ball is shown.

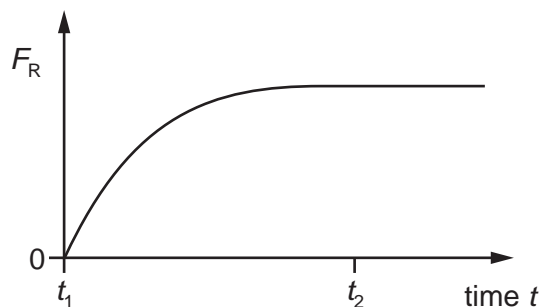

At which times are the speed of the ball zero, the speed at a maximum and the acceleration zero?

	zero speed	maximum speed	zero acceleration
<b>A</b>	$t_1$	$t_2$	$t_1$
<b>B</b>	$t_1$	$t_2$	$t_2$
<b>C</b>	$t_2$	$t_1$	$t_1$
<b>D</b>	$t_2$	$t_1$	$t_2$

14 Which diagram best shows the forces acting on a ball falling at a constant velocity through a liquid?

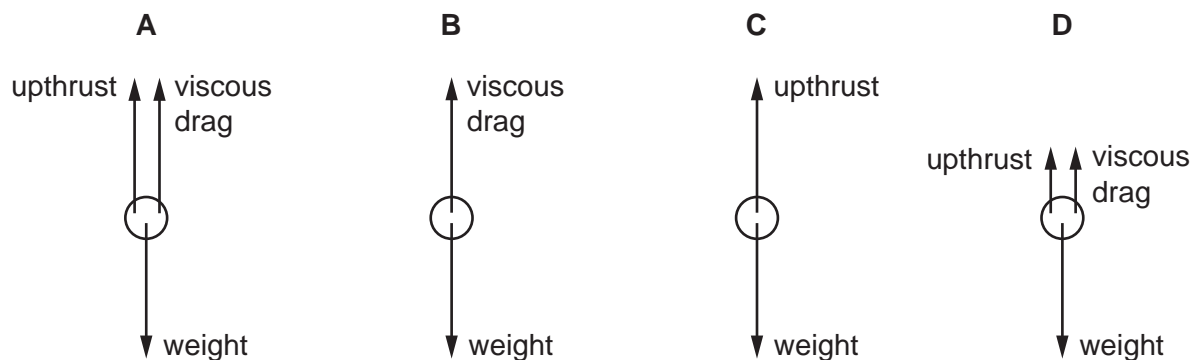



- 15 A minimum torque of 20 N m must be applied to the lid of a jar for it to open. The radius of the lid is 4.0 cm.

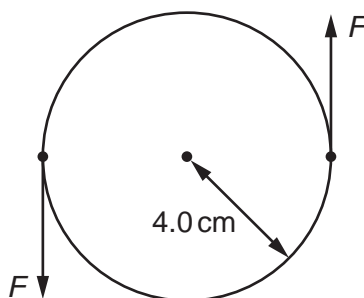

What is the minimum force  $F$  that must act on each side of the lid in order to open it?

- A 2.5 N      B 5.0 N      C 250 N      D 500 N
- 16 The diagram shows the brake system of a car.

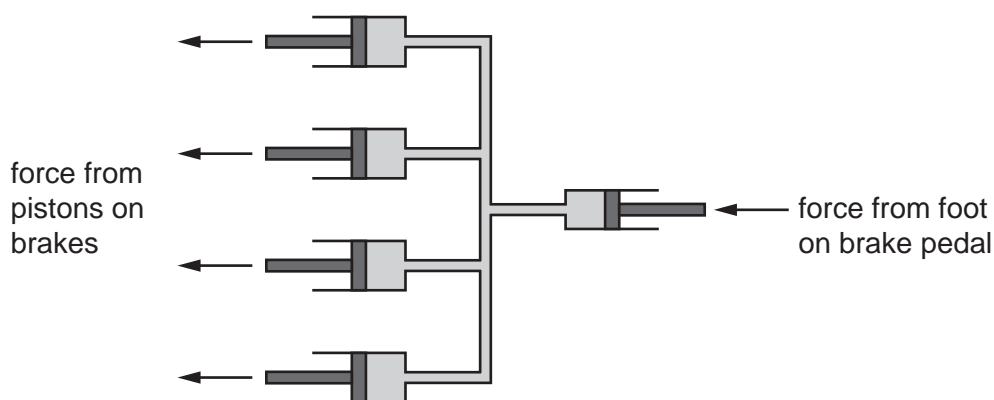

The pipes are filled with incompressible liquid. When a force is applied to the brake pedal, the pressure in the liquid increases and applies a force to each of the four wheels.

The area of the piston connected to the brake pedal is  $8 \text{ cm}^2$ .

The area of each piston connected to the brakes is  $12 \text{ cm}^2$ .

A force of 800 N is applied by the foot to the brake pedal.

What is the force applied to each brake?

- A 300 N      B 530 N      C 1200 N      D 4800 N

- 17 A rigid cross-shaped structure having four arms PO, SO, QO and RO, each 1.00 m long, is pivoted at O. Forces act on the ends of the arms and on the midpoints of the arms as shown.

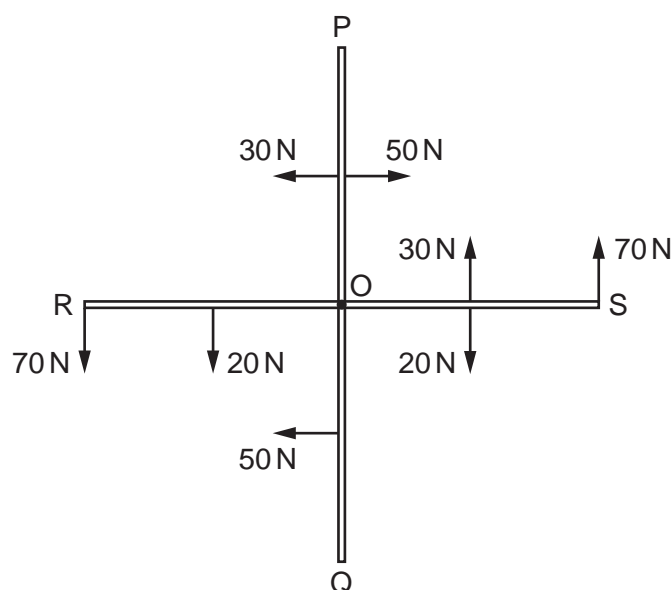

What is the magnitude of the resultant moment on the structure about O?

- A 45 Nm      B 90 Nm      C 120 Nm      D 190 Nm
- 18 On the surface of a planet, 30 J of work is done against gravity to raise a mass of 1.0 kg through a height of 10 m.
- How much work must be done to raise a mass of 4.0 kg through a height of 5.0 m on this planet?
- A 15 J      B 60 J      C 120 J      D 200 J
- 19 The speed of a car increases from  $10 \text{ m s}^{-1}$  to  $15 \text{ m s}^{-1}$  and its kinetic energy increases by  $E_1$ .
- Later, the speed of the car increases from  $15 \text{ m s}^{-1}$  to  $25 \text{ m s}^{-1}$  and its kinetic energy increases by  $E_2$ .
- What is the ratio  $\frac{E_2}{E_1}$ ?
- A 1.6      B 2.6      C 3.2      D 4.0
- 20 A car travels at a constant speed of  $25 \text{ m s}^{-1}$  up a slope. The wheels driven by the engine exert a forward force of 3000 N. There is a drag force due to air resistance and friction of 2100 N. The weight of the car has a component down the slope of 900 N.
- What is the rate at which thermal energy is dissipated?
- A zero      B  $2.3 \times 10^4 \text{ W}$       C  $5.3 \times 10^4 \text{ W}$       D  $7.5 \times 10^4 \text{ W}$

21 Which force-extension graph shows plastic deformation of a sample of material?

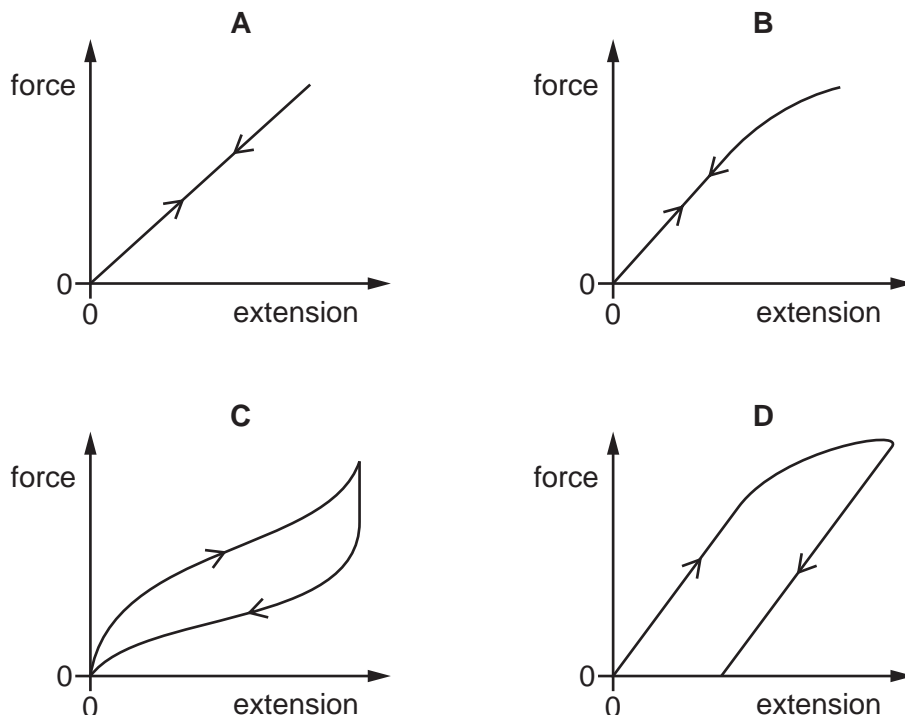

22 Four solid steel rods, each of length 2.0 m and cross-sectional area  $250 \text{ mm}^2$ , equally support an object weighing 10 kN. The weight of the object causes the rods to contract by 0.10 mm.

What is the Young modulus of steel?

- A  $2.0 \times 10^8 \text{ Nm}^{-2}$
- B  $2.0 \times 10^{11} \text{ Nm}^{-2}$
- C  $8.0 \times 10^8 \text{ Nm}^{-2}$
- D  $8.0 \times 10^{11} \text{ Nm}^{-2}$

23 High-frequency sound waves with frequency 2.0 MHz travel with a speed of  $2.0 \text{ km s}^{-1}$  through a liquid.

What is the shortest distance between a compression and a rarefaction (expansion) in the liquid?

- A 0.5 mm
- B 1.0 mm
- C 5.0 mm
- D 10.0 mm

- 24 A transverse progressive wave of wavelength  $\lambda$  is set up on a stretched string. The graph shows the variation of displacement  $y$  with distance  $x$  at a particular instant of time. The displacement where distance  $x = \frac{\lambda}{8}$  is  $y_1$ .

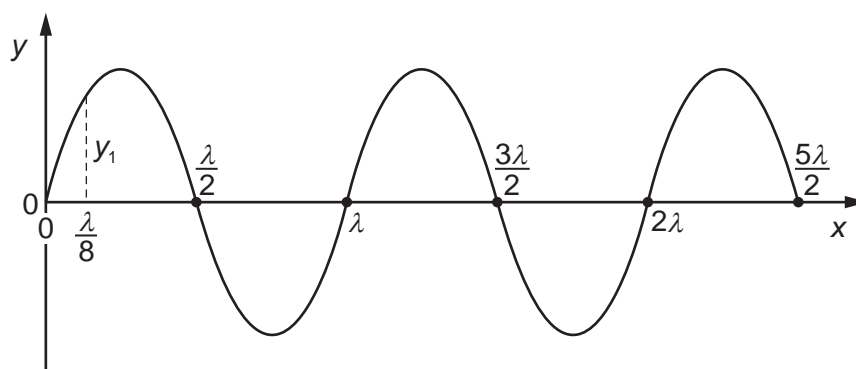

What are the next two values of  $x$  where the displacement  $y$  is again equal to  $y_1$ ?

- A  $\frac{3\lambda}{8}$  and  $\frac{5\lambda}{8}$
- B  $\frac{3\lambda}{8}$  and  $\frac{9\lambda}{8}$
- C  $\frac{5\lambda}{8}$  and  $\frac{9\lambda}{8}$
- D  $\frac{9\lambda}{8}$  and  $\frac{17\lambda}{8}$
- 25 A man standing next to a stationary train hears sound of frequency 400 Hz emitted from the train's horn. The train then moves directly away from the man and sounds its horn when it has a speed of  $50 \text{ m s}^{-1}$ . The speed of sound is  $340 \text{ m s}^{-1}$ .

What is the difference in frequency of the sound heard by the man on the two occasions?

- A 51 Hz                      B 69 Hz                      C 349 Hz                      D 469 Hz

- 26 A stationary wave is formed on a stretched string. The diagram illustrates the string at an instant of time when the displacement of the string is at its maximum.

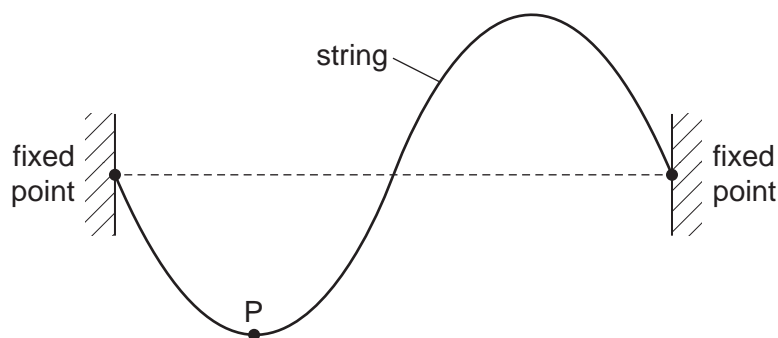

The frequency of the wave is 250 Hz. Point P on the string has a vertical displacement of  $-1.0$  mm.

What will be the vertical displacement of the point P after a time of 5 ms?

- A**  $-1.0$  mm      **B** zero      **C**  $+0.5$  mm      **D**  $+1.0$  mm
- 27 Observable interference fringes are produced using light from a double slit. The intensity of the light emerging from each slit is initially the same.
- The intensity of the light emerging from one of the slits is now reduced.
- How does this affect the interference pattern?
- A** The bright fringes and the dark fringes all become brighter.  
**B** The bright fringes and the dark fringes all become darker.  
**C** The bright fringes become brighter and the dark fringes become darker.  
**D** The bright fringes become darker and the dark fringes become brighter.
- 28 Monochromatic light of wavelength 450 nm passes through two parallel slits 0.30 mm apart. Bright fringes are observed on a screen 2.0 m away.

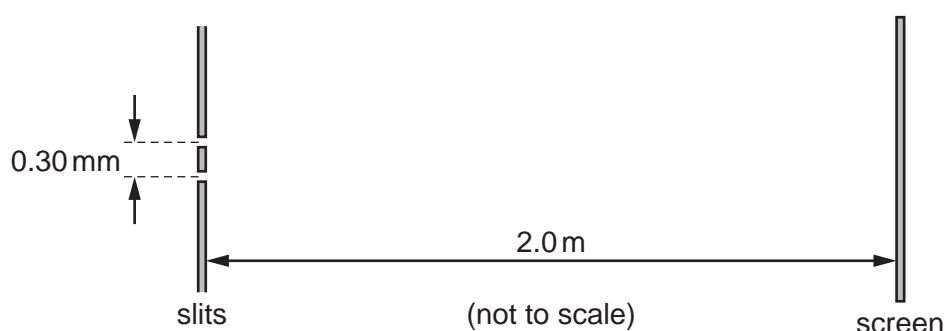

How far apart are the bright fringes on the screen?

- A** 1.3 mm      **B** 1.5 mm      **C** 3.0 mm      **D** 6.0 mm

- 29 A microwave transmitter is placed at a fixed distance from a flat reflecting surface, as shown.

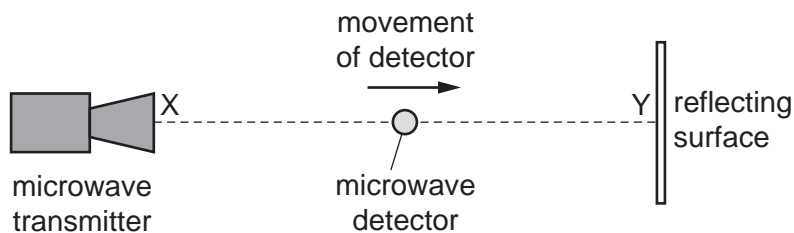

A microwave detector is moved steadily in a straight line from X to Y. A series of maxima and minima of intensity is obtained. The distance between adjacent maxima is 1.5 cm.

What is the frequency of the microwave radiation?

- A  $1.0 \times 10^8$  Hz  
 B  $2.0 \times 10^8$  Hz  
 C  $1.0 \times 10^{10}$  Hz  
 D  $2.0 \times 10^{10}$  Hz
- 30 Two parallel circular metal plates X and Y, each of diameter 18 cm, have a separation of 9.0 cm. A potential difference of 9.0 V is applied between them.

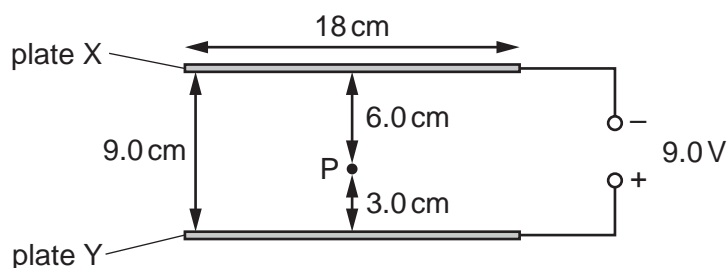

Point P is 6.0 cm from the surface of plate X and 3.0 cm from the surface of plate Y.

What is the electric field strength at P?

- A  $50 \text{ NC}^{-1}$       B  $100 \text{ NC}^{-1}$       C  $150 \text{ NC}^{-1}$       D  $300 \text{ NC}^{-1}$

- 31 An oil drop has mass  $m$  and charge  $q$ . The drop is held stationary in an electric field between two parallel horizontal plates, distance  $d$  apart, as shown.

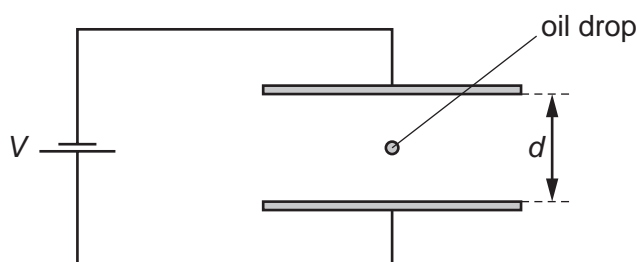

The potential difference between the plates is  $V$  and the acceleration of free fall is  $g$ .

What is the charge-to-mass ratio  $\frac{q}{m}$  of the oil drop?

- A  $\frac{gd}{V}$       B  $\frac{V}{dg}$       C  $\frac{gV}{d}$       D  $\frac{d}{Vg}$
- 32 The diagram shows a junction in a circuit where three wires P, Q and R meet. The currents in P and Q are 1 A and 3 A respectively, in the directions shown.

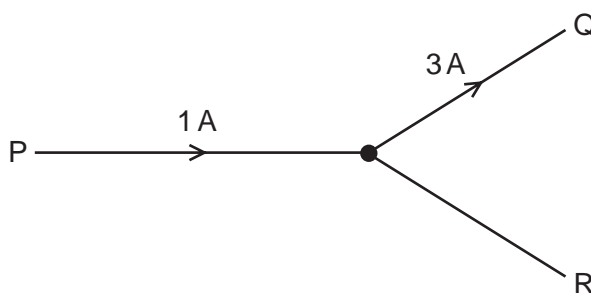

How much charge passes a given point in wire R in a time of 5 s?

- A 0.4 C      B 2 C      C 10 C      D 20 C
- 33 A wire carries a current of 2.0 A for 1.0 hour.
- How many electrons pass a point in the wire in this time?
- A  $1.2 \times 10^{-15}$       B  $7.2 \times 10^3$       C  $1.3 \times 10^{19}$       D  $4.5 \times 10^{22}$

- 34 The diagram shows an electric circuit in which the resistance of the external resistor is  $2R$  and the internal resistance of the source is  $R$ .

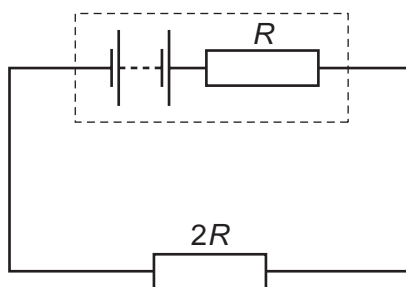

What is the ratio  $\frac{\text{power in internal resistance}}{\text{power in external resistor}}$  ?

- A  $\frac{1}{4}$       B  $\frac{1}{2}$       C 2      D 4
- 35 The graph shows the variation with potential difference  $V$  of the current  $I$  in components X, Y and Z.

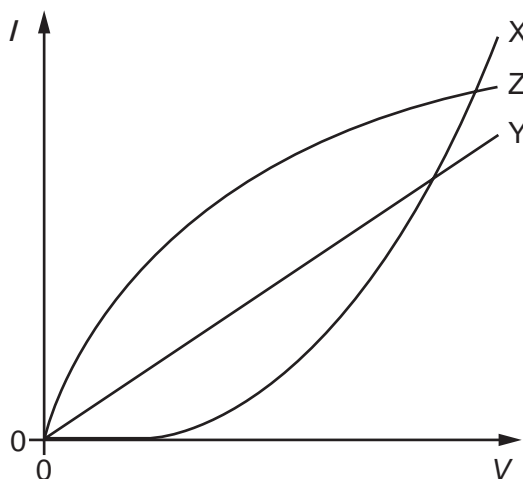

Which row correctly identifies the components?

	metallic conductor at constant temperature	semiconductor diode	filament lamp
<b>A</b>	X	Z	Y
<b>B</b>	Y	X	Z
<b>C</b>	Y	Z	X
<b>D</b>	Z	Y	X



36 Four statements about either potential difference or electromotive force are listed.

- 1 It involves changing electrical energy into other forms.
- 2 It involves changing other energy forms into electrical energy.
- 3 It is the energy per unit charge to move charge around a complete circuit.
- 4 It is the work done per unit charge by the charge moving from one point to another.

Which statements apply to potential difference and which apply to electromotive force?

	potential difference	electromotive force
<b>A</b>	1 and 3	2 and 4
<b>B</b>	1 and 4	2 and 3
<b>C</b>	2 and 3	1 and 4
<b>D</b>	2 and 4	1 and 3

37 In the circuit shown, there is a current of 3.0 A in the 2.0 Ω resistor.

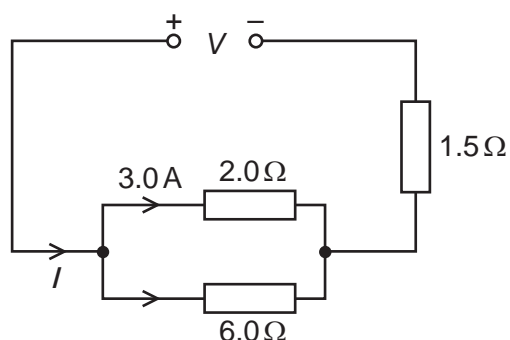

What are the values of the current  $I$  delivered by the power supply and the voltage  $V$  across it?

	$I/A$	$V/V$
<b>A</b>	3.0	10.5
<b>B</b>	4.0	9.0
<b>C</b>	4.0	12
<b>D</b>	12	18

- 38 In the circuit below, P is a potentiometer of total resistance  $10\Omega$  and Q is a fixed resistor of resistance  $10\Omega$ . The battery has an e.m.f. of  $4.0\text{V}$  and negligible internal resistance. The voltmeter has a very high resistance.

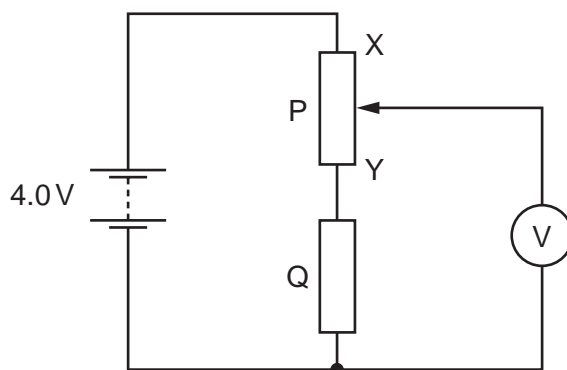

The slider on the potentiometer is moved from X to Y and a graph of voltmeter reading  $V$  is plotted against slider position.

Which graph is obtained?

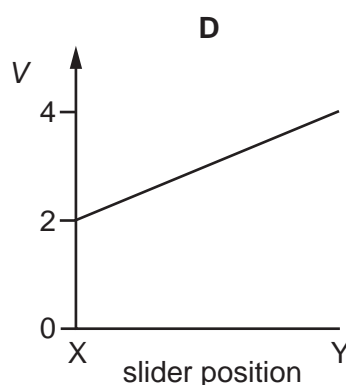
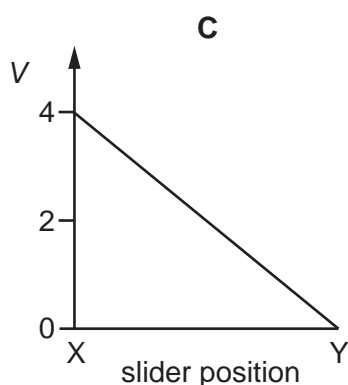
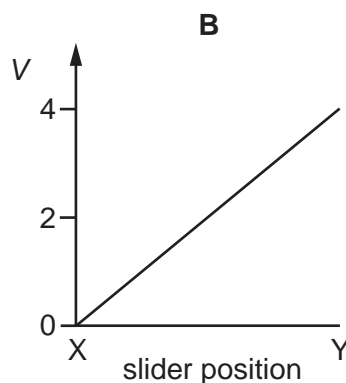
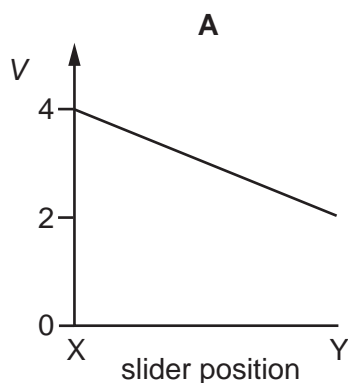

39 The calcium nuclide  $^{42}_{20}\text{Ca}$  is formed by  $\beta^-$  decay.

What are the nucleon (mass) number and proton (atomic) number of the unstable nuclide that underwent  $\beta^-$  decay to form the calcium nuclide?

	nucleon number	proton number
<b>A</b>	41	19
<b>B</b>	41	21
<b>C</b>	42	19
<b>D</b>	42	21

40 Which diagram represents the structure of an antineutron?

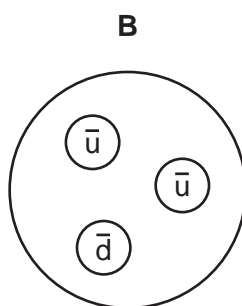
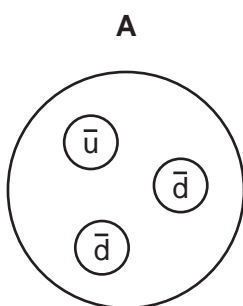

key

u up quark

d down quark

$\bar{u}$  up antiquark

$\bar{d}$  down antiquark

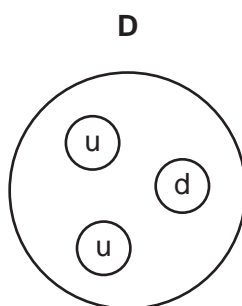
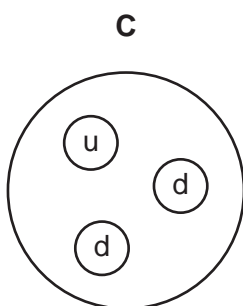

---

Permission to reproduce items where third-party owned material protected by copyright is included has been sought and cleared where possible. Every reasonable effort has been made by the publisher (UCLES) to trace copyright holders, but if any items requiring clearance have unwittingly been included, the publisher will be pleased to make amends at the earliest possible opportunity.

To avoid the issue of disclosure of answer-related information to candidates, all copyright acknowledgements are reproduced online in the Cambridge International Examinations Copyright Acknowledgements Booklet. This is produced for each series of examinations and is freely available to download at [www.cie.org.uk](http://www.cie.org.uk) after the live examination series.

Cambridge International Examinations is part of the Cambridge Assessment Group. Cambridge Assessment is the brand name of University of Cambridge Local Examinations Syndicate (UCLES), which is itself a department of the University of Cambridge.